



sistema video 4+n
video system 4+n

SYNTHESI
2000

 **AMPLYVOX**

ED. 1-2004

INDEX:

Description	Diagram	Page
Section of wires		2/UK
Suggestions for the correct installation		3/UK
Terminal functions monitor Synthesi code 8435/5		4/UK
Power supply terminal functions code 8605		5/UK
Audio speaker unit terminal functions code 2055		5/UK
Camera group terminal functions code 8055/29 – 8055/80		6/UK
Interface module for external camera		6/UK
Automatic switch terminal functions code 8845		7/UK
Connection diodes circuit code 2610/4		8/UK
VIDEO DOOR ENTRY SYSTEM SYNTHESI (4+n)		
Single residence kit	5801#	1
Single residence kit with external camera	5811#	2
Dual residence kit	5802#	3
Dual residence kit with external camera	5812#	4
Multi users video door entry system	5820#	5
Automatic switching for two entrance panels : one video and one only audio	5840#	6
Automatic switching for two video entrance panels	5841#	7
Automatic switching for three or more main video entrance panels	5851#	8
Video distributor		9
Monitor in parallel		10
Telephone in parallel		10
Three monitors in parallel without video distributor		11
Monitor with video recall		12
Apartment entrance door call		12
Passive repeater for additional call		13
Long distance connection		13

NOTE

- a) AMPLYVOX S.p.A suggests to use original components only.
- b) AMPLYVOX S.p.A. reserves the right to modify the design, construction, composition and equipment as it shall think fit without notifying the buyer and to supply products which may not be in strict accordance with agreed specifications.

TO FACILITATE THE READING OF THE DIAGRAM, TERMINAL DATA MAY NOT CORRESPOND TO THE POSITION INDICATED ON THE EQUIPMENT.

TO AVOID DAMAGE TO THE PRINTED CIRCUIT, WE SUGGEST THAT TERMINALS ARE NOT OVER TIGHENED.

LEGEND :

- Y DOOR OPENER BUTTON
- J APARTMENT CALL
- S.E. ELECTRIC LOCK 12Vac – 18VA
- R CHARGE RESISTOR 75 ohm ½ W
- ⊗ NAME LABEL FESTOON BULB 24V – 3W

Section of wires				
Distance	Monitor			Power supply
	+ O	R X CP	1 2	F H +F OH
50 mt.	1 mm ²	0.5 mm ²	0.3 mm ²	1.5 mm ²
100 mt.	1.5 mm ²	1 mm ²	0.3 mm ²	2 mm ²
200 mt.	2.5 mm ²	1.5 mm ²	0.3 mm ² twisted	2.5 mm ²

SUGGESTED INSTALLATION HEIGHTS :

Video entrance panel
(code 806.../n)
(Mosaico)

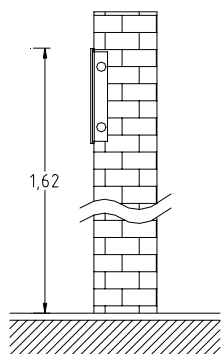

Monitor wall mount bracket
(code 8435/5)

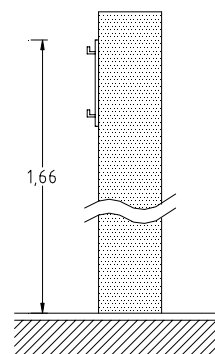

Suggestions for the Correct installation

- 1) Do not execute any connection, replacement or operation with the system powered.
- 2) Be carefull installing the external video entrance panel to the right indicated height and avoid installing the camera group in direct view of sunlight.
- 3) Do not run the cables of the video door system in the same duct of the mains network.
- 4) There are more than one "H" terminals on the equipments, it makes no difference which "H" terminal is used.
- 5) The CCD video camera is normally supplied with infrared leds built in, to allows a correct vision of the visitor.
- 6) To supply the name label festoon bulbs in the entrance panel a dedicated trasformer and its wires connection are suggested.

Preliminary checks

Before main connections:

- 1) Check that the connections are made following the drawing supplied with the equipment.
- 2) Check that no short circuit exists between terminals "H" and "+F".
- 3) Check that no short circuit exists between terminals "O" and "+".
- 4) The wires "1" and "2" starting from the camera group must present a resistance of about 75 ohms.
Note: this measurement is not valid for the single residence video kit.

Test of operations

- 1) Power the system.
- 2) Push the call button of the external video entrance panel and check if :
 - the electronic call sounds at the monitor.
 - the monitors image is clear, stable and defined.
 - the image needs regulating (operate on brightness and contrast controls).
- 3) Wait for the automatic turn off of the monitor, then repeat the call to the other apartments.
A special circuit in the camera group avoids the simultaneous turn on of more than one monitor.
- 5) The phonic test must be effected talking at a distance of 30 cms. from the external video entrance panel.
The volume of the amplifiers in the external audio unit is normally factory set, however if the amplification proves to be too high or too low, this can be adjusted accordingly via the two potentiometers "A" and "B" which can be found at the back of the external audio unit.

"A" = regulates the volume from the inside to the outside

"B" = regulates the volume from the outside to the inside

The amplification settings must be carried out with the unit in operation, so as to hear the effects of the settings.

It is important to start the adjustments with potentiometer "A".

However it is important to avoid increasing the volume to a very high level that will produce the feedback whistle due to the larsen effect.

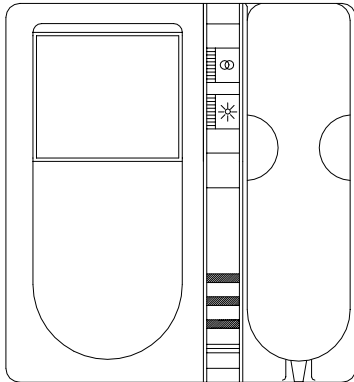

MONITOR SYNTHESI Code 8435/5

- . Picture tube: flat 4" screen.
- . Electronic call: loudspeaker.
- . Electronic front door apartment call: loudspeaker (different frequency).
- . 1 push-button: electric lock door release.
- . 1 push-button: video recall.
- . 1 push-button: auxiliary services.
- . Controls: brightness – contrast.
- . Privacy: built-in (can be excluded).
- . Video connection: with video distributor or “ in – out ” system.

Dimensions : 204 x 220 x 50 mm
 Housing : technopolymers

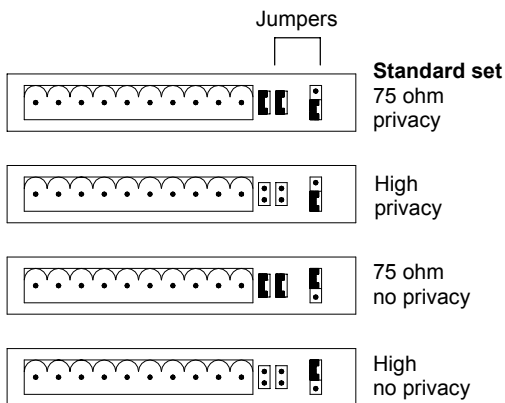

IMPORTANT !
 Use jumpers in the following mode :
 Use both jumpers (ref. 75 ohm) in systems with video distributors.
 Remove both jumpers (ref. High) in systems without video distributors (in – out).

IMPORTANT !
 All monitors must have the “Privacy” jumper in the same position.

TERMINAL FUNCTIONS

T.	Value	Function	Note
1		Positive video signal	Composite video signal 1 Vpp
2		Negative video signal	Composite video signal 1 Vpp
O	0 V	General earth	All voltage reference level
+	+18 V =	Timed voltage	Stand on when timer is working
R	+10 V = closed + 5 V = opened - 5 V = 0 V	Phonic input Electronic call Electric lock release control	
X	+18 V =	Electronic front door call	
CP		Video recall	
CL	NO contact	Auxiliary contact at rest	Special function
CC	Common contact	Auxiliary contact common	Special function
CR	NC contact	Auxiliary contact at rest	Special function

Code 8435/5

POWER SUPPLY Code 8605

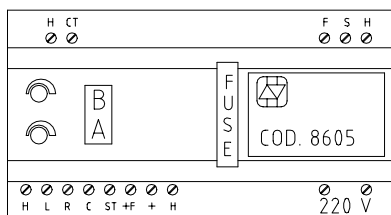

Dimension : 185 x 100 x 77 mm

Housing : ABS (DIN module)

Protections : Fuse T 200 mA (primary trasformer)

Fuse F 3.15 A (secondary trasformer)

TERMINAL FUNCTIONS

Code 8605

T.	Value	Function	Note
H	0 V	General earth	All voltage reference level
F	16 V ~	Camera group supply	Stand on terminal
+F	+18 V =	Camera group supply	Stand on terminal
CT		External timer set	Additional supply function
+	+18 V =	Timed voltage	Additional supply function
ST	+18 V =	Voltage present at rest	Special function
L	NO contact	Auxiliary contact at rest	Special function
R	NC contact	Auxiliary contact at rest	Special function
C	Common contact	Auxiliary common contact	Special function
S	22 V ~	A.C. voltage-services supply	Stand on terminal
220	230 Vac	Input voltage	Main

AUDIO SPEAKER UNIT Code 2055

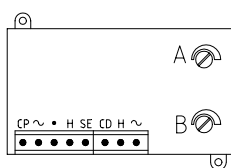

Dimensions : 94 x 57 x 35 mm

Hosing : ABS

Regulations : Potentiometer A (volume from the inside to the outside)

Potentiometer B (volume from the outside to the inside)

TERMINAL FUNCTIONS

Code 2055

T.	Value	Function	Note
CP		Common push button	Yellow
~	16 V ~	Supply	Red
•		Switch set	Green
H	0 V	General earth	Black
SE		Electric lock door release	Blue
CD		Common anode diodes circuits	Brown
H	0 V	General earth	Black
~	16 V ~	Supply	Red

CAMERA GROUP

Cod. 8055/80

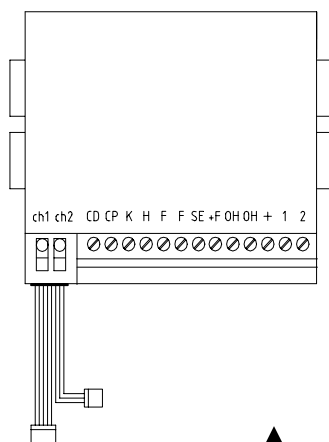

To use with
"COMPONIBILE" entrance panel



Cod. 8055/29

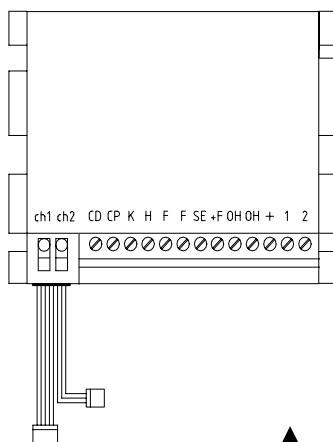

To use with
"MOSAICO" entrance panel

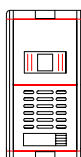

Cod. 8055/TX

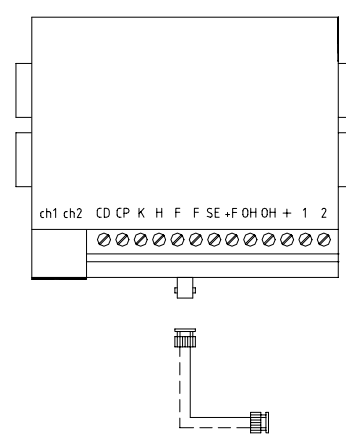

To use with
External camera

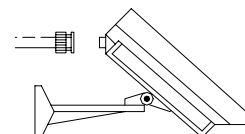

TERMINAL FUNCTIONS

Code 8055 / 80
Code 8055 / 29

T.	Value	Function	Note
CD		Common anode diodes circuits	
CP		Common push button	
K	+12 V = at rest 0 V call	Switch set	
H	0 V	General earth	All voltage reference level
F	16 V ~	Camera group supply	Stand on terminal
SE	16 V ~ opened 0 V closed	Electric lock door release	
OH	0 V	General earth	All voltage reference level
+F	+18 V =	Camera group supply	Permanent
+	+18 V =	Timed voltage	60 sec.
1		Positive video signal	Composite video signal 1 Vpp
2		Negative video signal	Composite video signal 1 Vpp
Ch1		Cathode diode	Used only in the video kit
Ch2		Cathode diode	Used only in the video kit

Cod. 8055 / TX

K	+12 V = at rest 0 V call	Switch set	
OH	0 V	General earth	All voltage reference level
+F	+18 V =	Camera group supply	Permanent
+	+18 V =	Timed voltage	60 sec.
1		Positive video signal	Composite video signal 1Vpp.
2		Negative video signal	Composite video signal 1Vpp.
	75 Ω	BNC Coaxial cable core	Composite video signal 1Vpp.

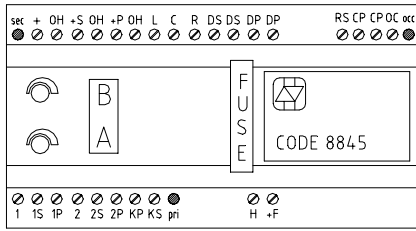

AUTOMATIC SWITCH Cod. 8845

Dimensions : 185 x 100 x 77 mm
 housing : ABS (DIN module)

Protections : fuse 1 A

LEDS :

- PRI** Common contacts close with NC contacts
- SEC** Common contacts close with NO contacts
- OCC** Busy signal works

ENGLISH

TERMINAL FUNCTIONS

T.	Value	Function	Note
+F	+18 V=	Supply	Stand on terminal
OH	0 V	General heart	All voltage reference level
KP	+12 V= at rest 0 V call	Reset control	
KS	+12 V= at rest 0 V call	Set control	
RS		Busy signal	Special function
OC		Busy signal	Special function
1		Positive video signal	Common contact
1P		Positive video signal	NC contact
1S		Positive video signal	NO contact
2		Negative video signal	Common contact
2P		Negative video signal	NC contact
2S		Negative video signal	NO contact
+	+18 V=	Monitor supply	Common contact
+P	+18 V=	Monitor supply	NC contact
+S	+18 V=	Monitor supply	NO contact
DS		Common anode diodes circuit	Common contact
DS		Common anode diodes circuit	NO contact
DP		Common anode diodes circuit	Common contact
DP		Common anode diodes circuit	NC contact
CP		Common push buttons	Common contact
CP		Common push buttons	NC contact
C		Auxiliary contact	Common contact
R		Auxiliary contact	NC contact
L		Auxiliary contact	NO contact

Code 8845

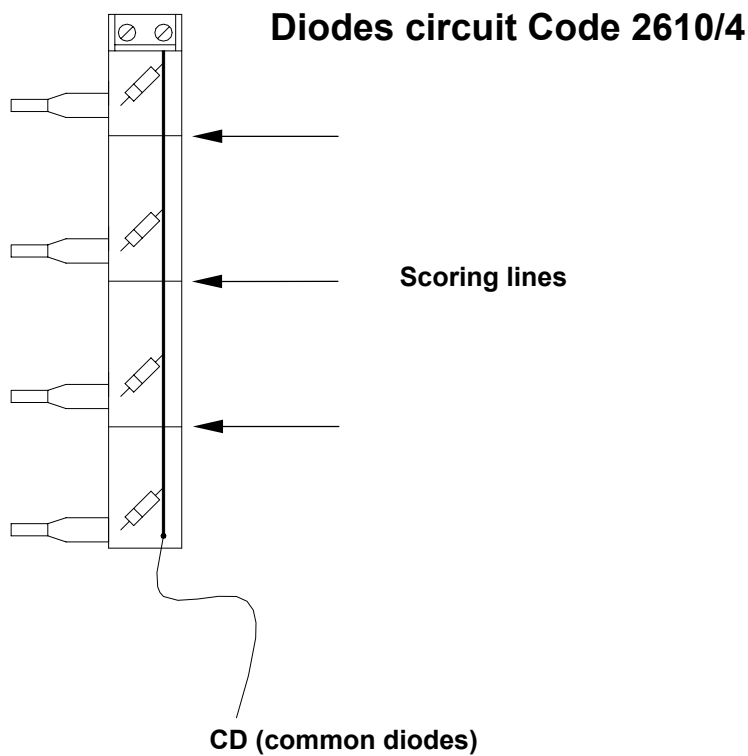
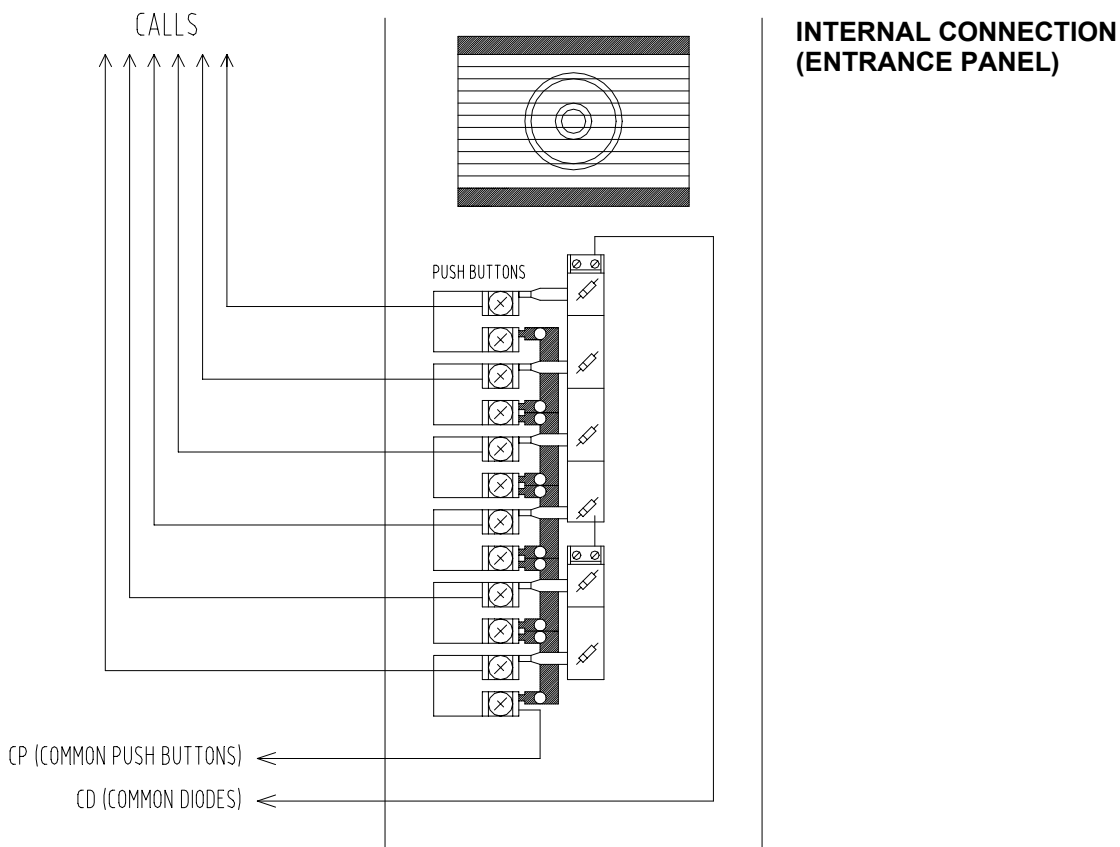

SYNTHESI
COD. 8435/5

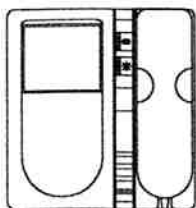

- R
- +
- 0
- 2
- 1
- CP
- X
- CR
- CC
- CL

PULSANTIERA
ENTRANCE PANEL

COD. 8505/P1

COD. 8061/1

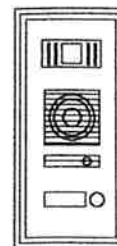

ALIMENTATORE
POWER SUPPLY
COD. 8605

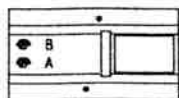

- +
- CT
- H
- +F
- F
- H
- 220

RETE
MAIN

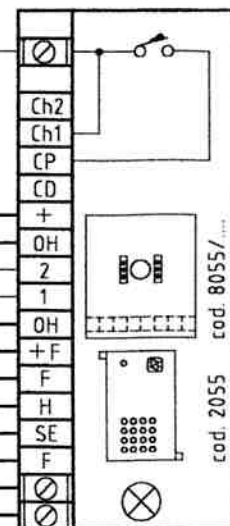

SCHEMI WIRING DIAGRAMS

Kit unifamiliare
Single residence kit

sch. 5801#

SYNTHESI
COD. 8435/5

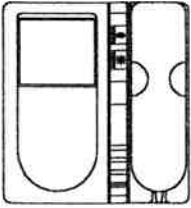

MODULO TELEC.
CAMERA MODULE
COD. 8055/TX

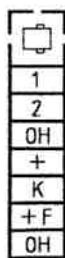
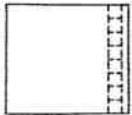

ALIMENTATORE
POWER SUPPLY
COD. 8605

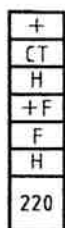
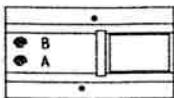

TELECAMERA IN CUSTODIA
EXTERNAL CAMERA

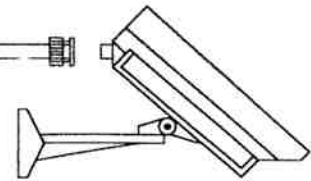
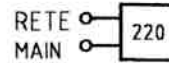

PULSANTIERA
ENTRANCE PANEL

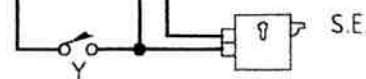
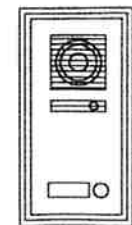
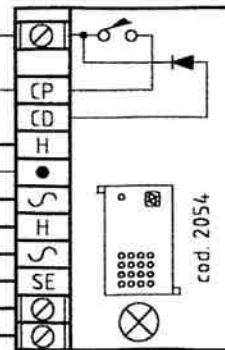

Kit unifamiliare con telecamera esterna
Single residence kit with external camera

sch. 5811#

SYNTHESI
COD. 8435/5

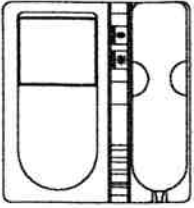

SYNTHESI
COD. 8435/5

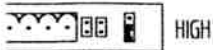
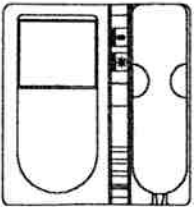

ALIMENTATORE
POWER SUPPLY
COD. 8605

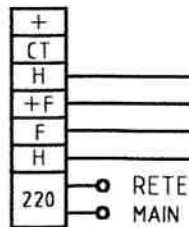
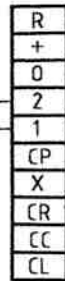
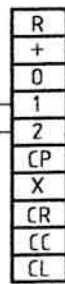
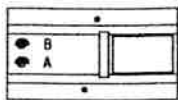

PULSANTIERA
ENTRANCE PANEL
COD. 8505/P2DP COD. 8061/2

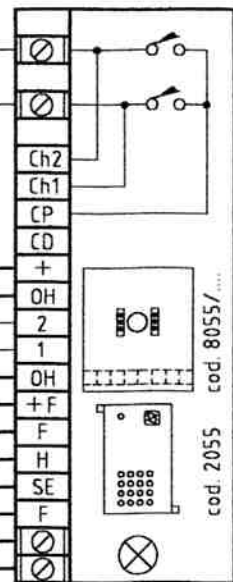
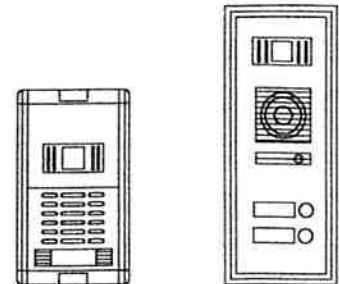

Kit bifamiliare
Dual residence kit

sch. 5802#

SCHEMI WIRING DIAGRAMS

SYNTHESI
COD. 8435/5

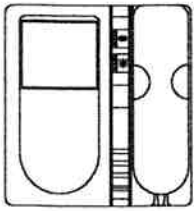

SYNTHESI
COD. 8435/5

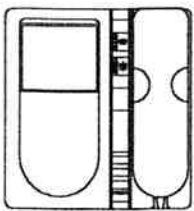

MODULO TELEC.
CAMERA MODULE
COD. 8055/TX

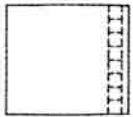

ALIMENTATORE
POWER SUPPLY
COD. 8605

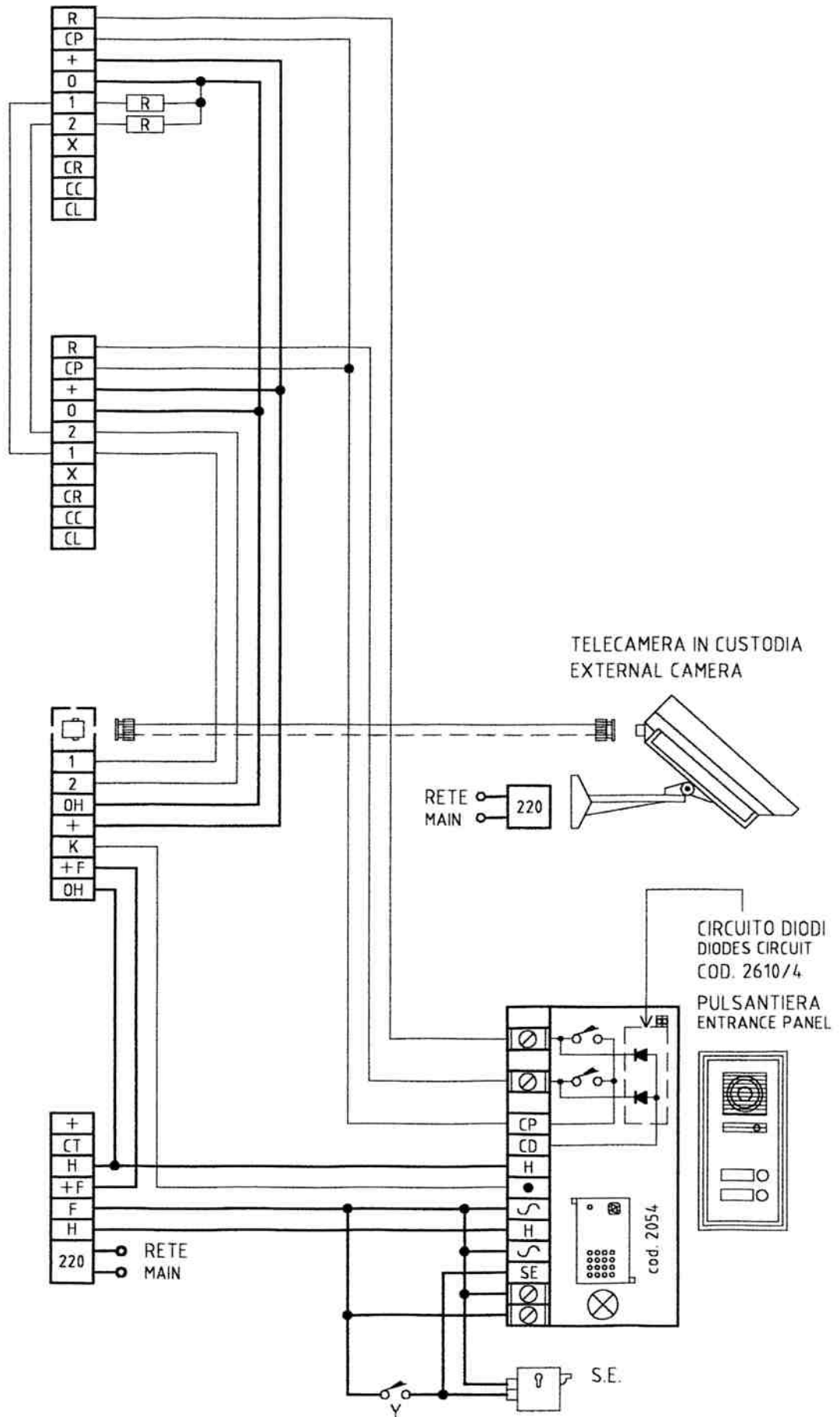
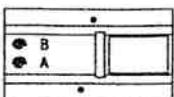

Kit bifamiliare con telecamera esterna
Dual residence kit with external camera

sch. 5812#

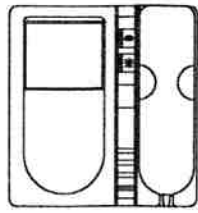

SYNTHESI
COD. 8435/5

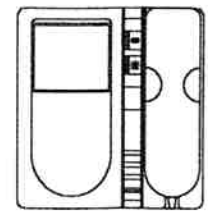
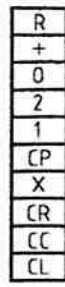

SYNTHESI
COD. 8435/5

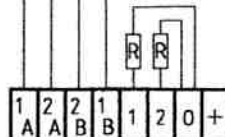

DERIVATORE
DISTRIBUTOR
COD. 865/4

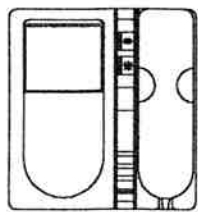

SYNTHESI
COD. 8435/5

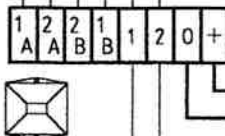
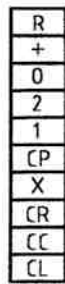

DERIVATORE
DISTRIBUTOR
COD. 865/4

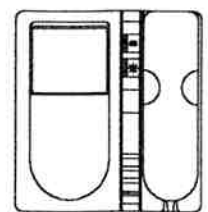

SYNTHESI
COD. 8435/5

CIRCUITO DIODI
DIODES CIRCUIT
COD. 2610/4
PULSANTIERA
ENTRANCE PANEL
COD. 806.../N

ALIMENTATORE
POWER SUPPLY
COD. 8605

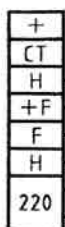
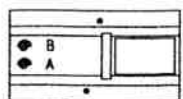

RETE
MAIN

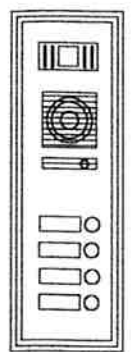
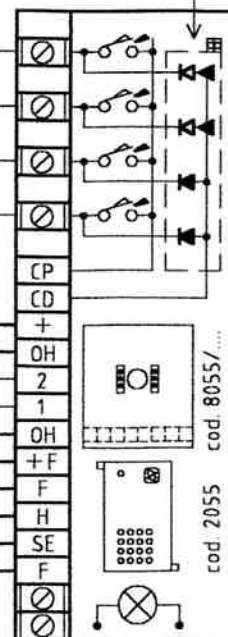

SCHEMI WIRING DIAGRAMS

Impianto plurifamiliare
Multi users video door entry system

sch. 5820#



installation wiring diagrams

VIDEO SYSTEM 4+n

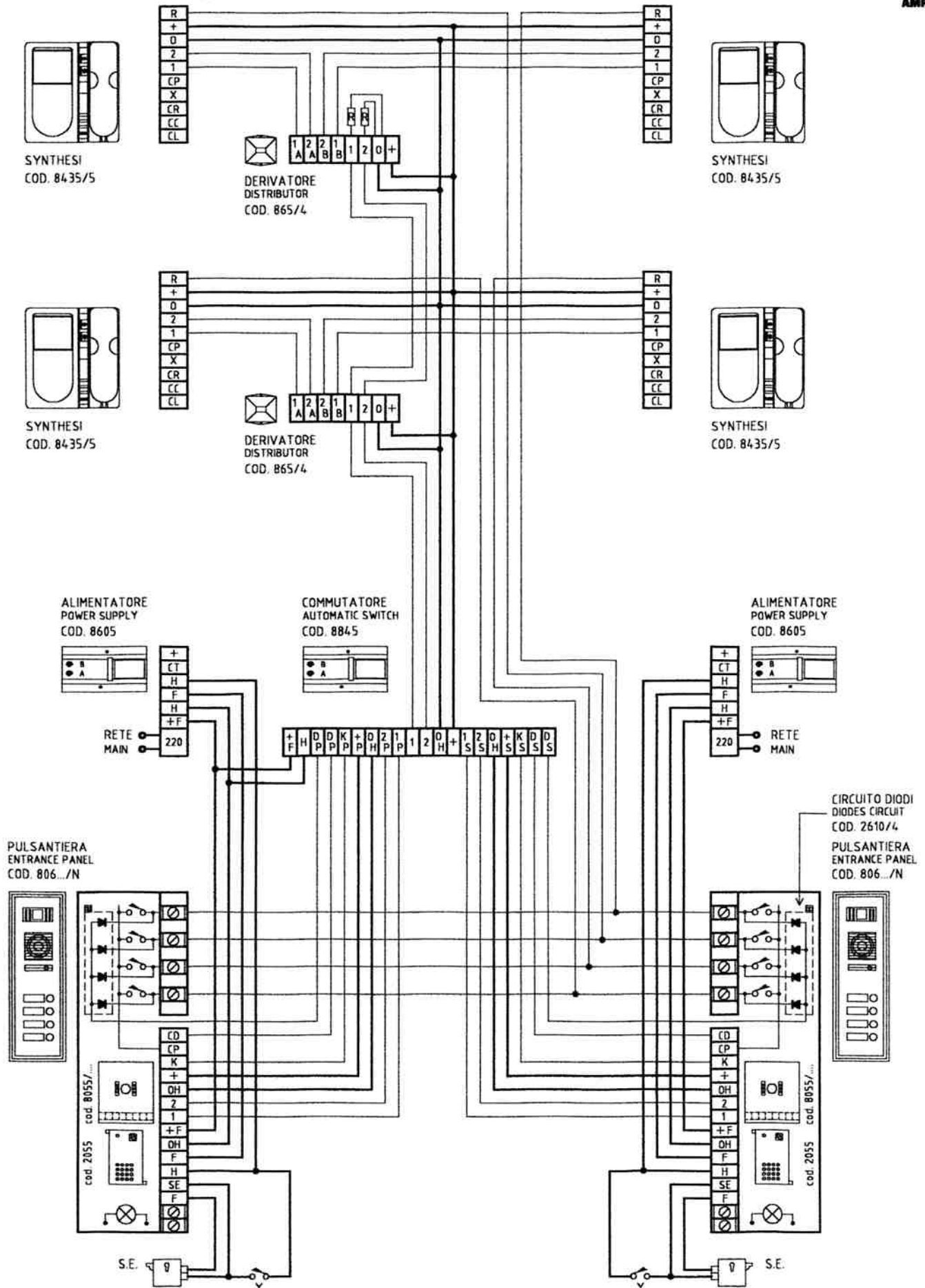

SCHEMI WIRING DIAGRAMS

Impianto commutato : due pulsantiere videocitofoniche
Automatic switching for two video entrance panel

sch. 5841#

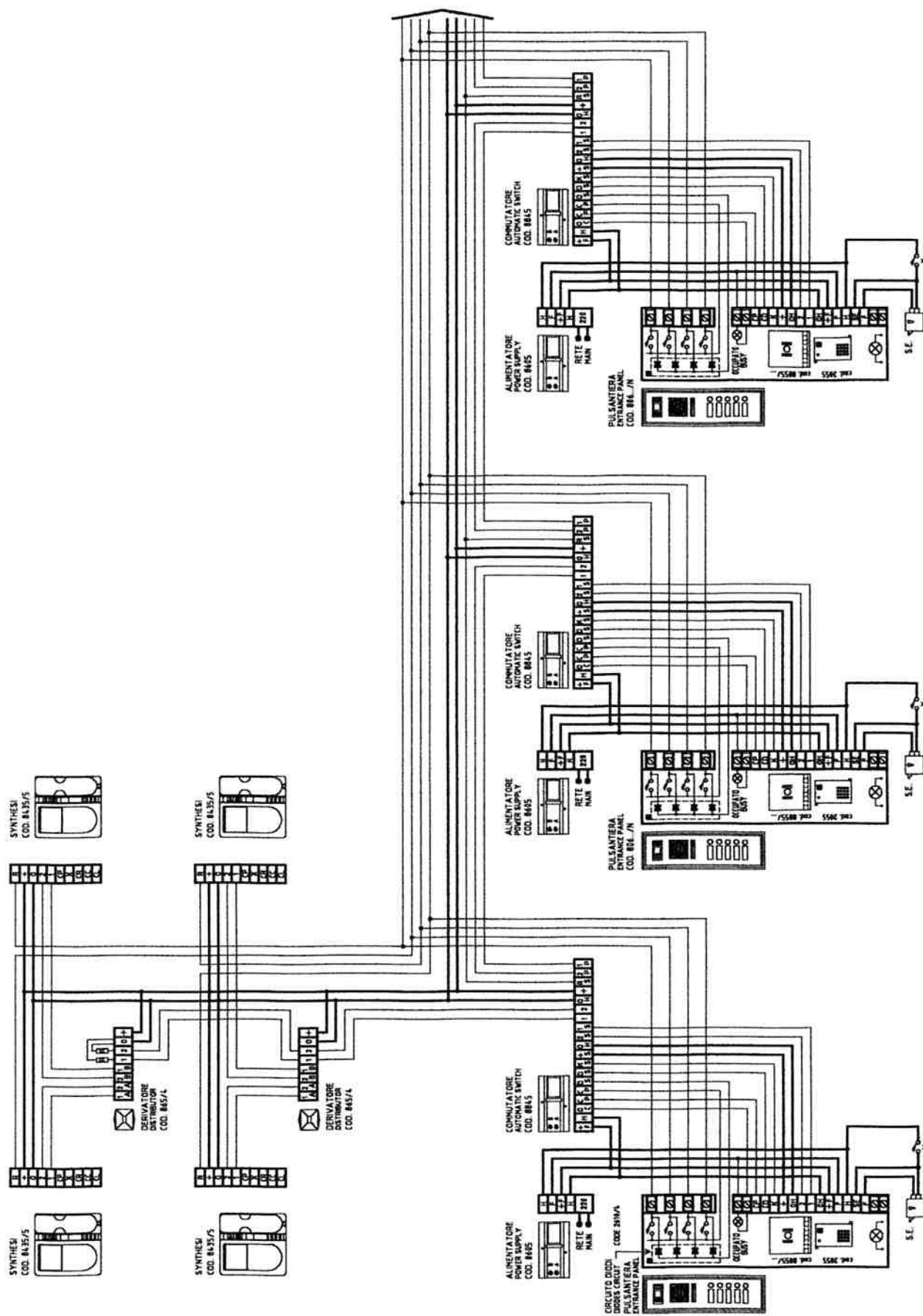

Impianto commutato : tre o più pulsantiere videocitfoniche principali
 Automatic switching for three or more main video entrance panels

sch. 5851 #

DERIVATORE VIDEO FINALE
FINAL VIDEO DISTRIBUTOR

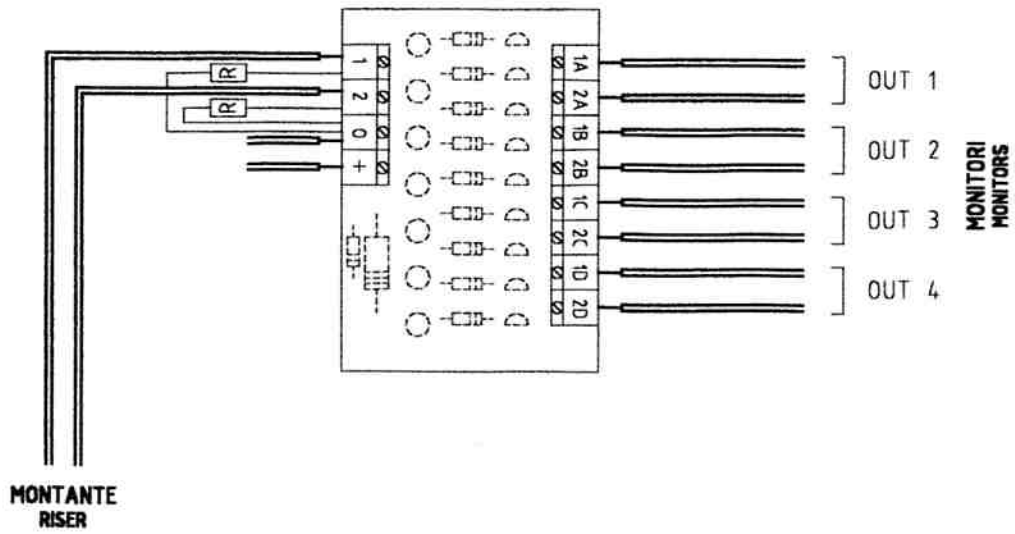

DERIVATORE VIDEO DI PIANO
FLOOR VIDEO DISTRIBUTOR

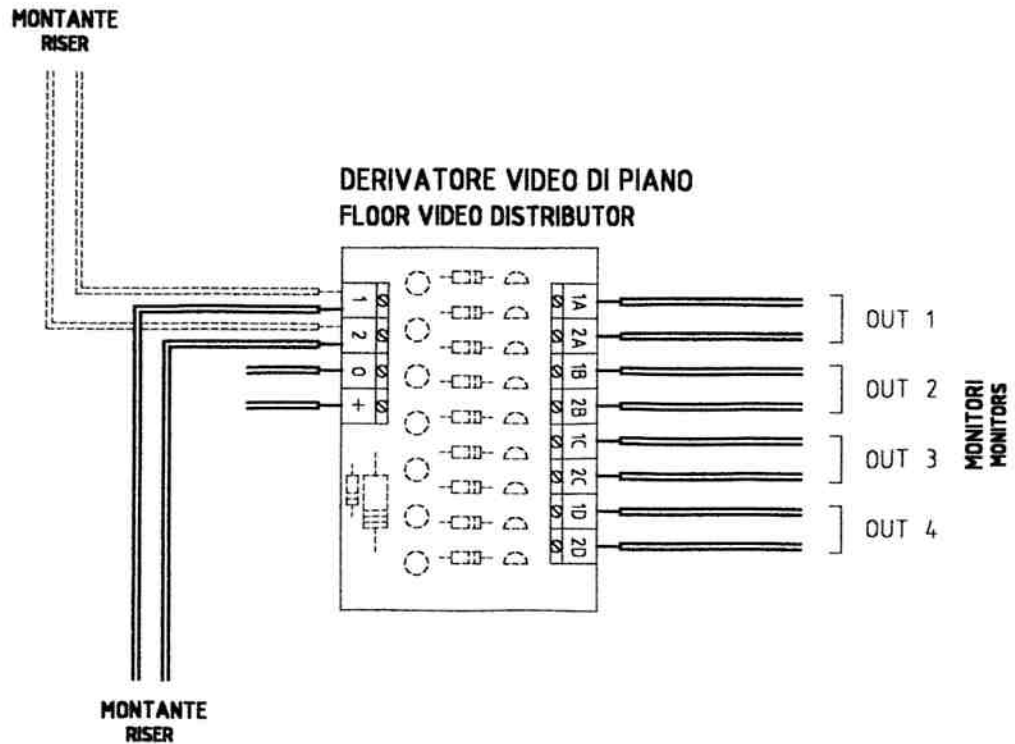

SCHEMI WIRING DIAGRAMS

Collegamento derivatore video
Video distributor Cod.865/4

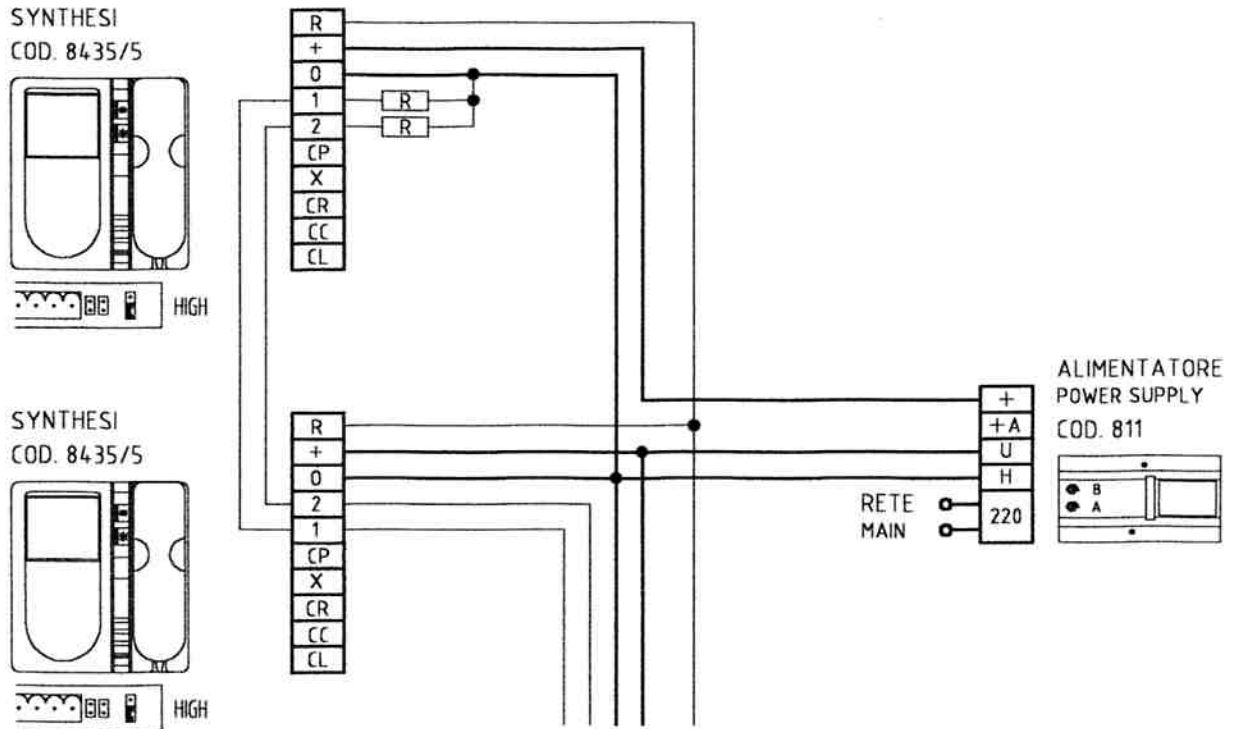

Collegamento di un monitor in parallelo
Monitor in parallel

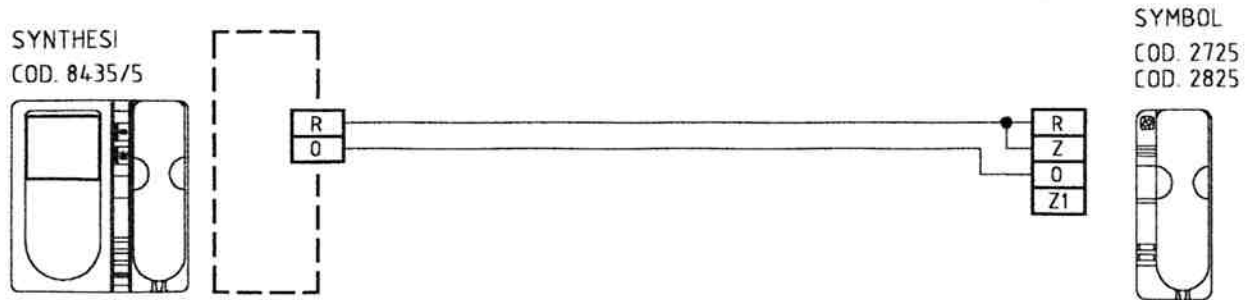

IMPORTANTE :

COD. 2725 : CITOFONO 2 FILI SENZA SEGRETO DI CONVERSAZIONE

COD. 2825 : CITOFONO 2 FILI CON SEGRETO DI CONVERSAZIONE

IMPORTANT :

CODE 2725 : TELEPHONE 2 WIRES WITHOUT PRIVACY

CODE 2825 : TELEPHONE 2 WIRES WITH PRIVACY

NOTE :

COLLEGARE MAX 2 CITOFONI IN PARALLELO

MAX 2 TELEPHONES IN PARALLEL.

Collegamento di un citofono in parallelo
Telephone in parallel



SYNTHESI
COD. 8435/5

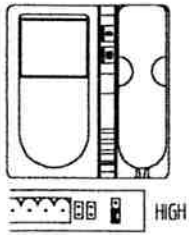

SYNTHESI
COD. 8435/5

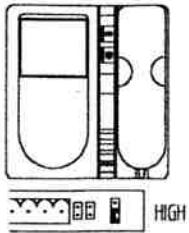

SYNTHESI
COD. 8435/5

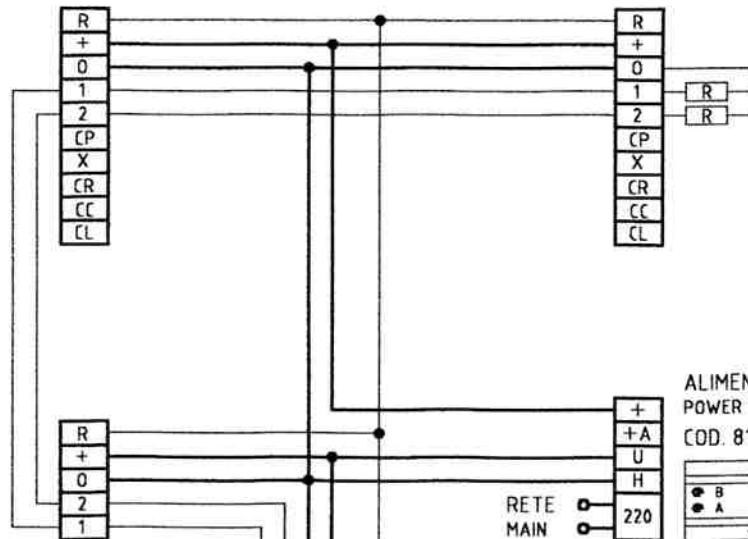
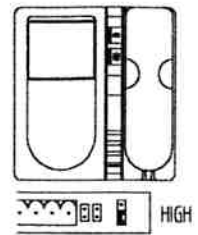

NOTE :

COLLEGARE MAX 3 MONITORI IN PARALLELO
MAX 3 MONITORS IN PARALLEL

ALIMENTATORE
POWER SUPPLY
COD. 8605

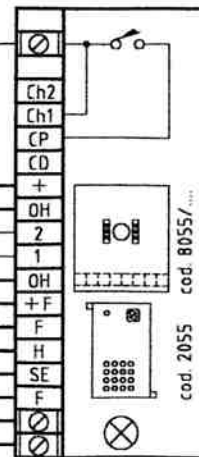
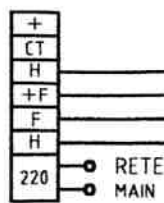
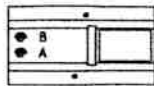

PULSANTIERA
ENTRANCE PANEL
COD. 8061/1

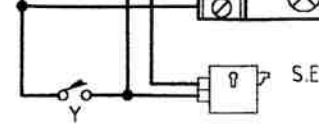
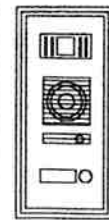

Collegamento di tre monitori in parallelo senza derivatore
Three monitors in parallel without video distributor

SCHEMI WIRING DIAGRAMS

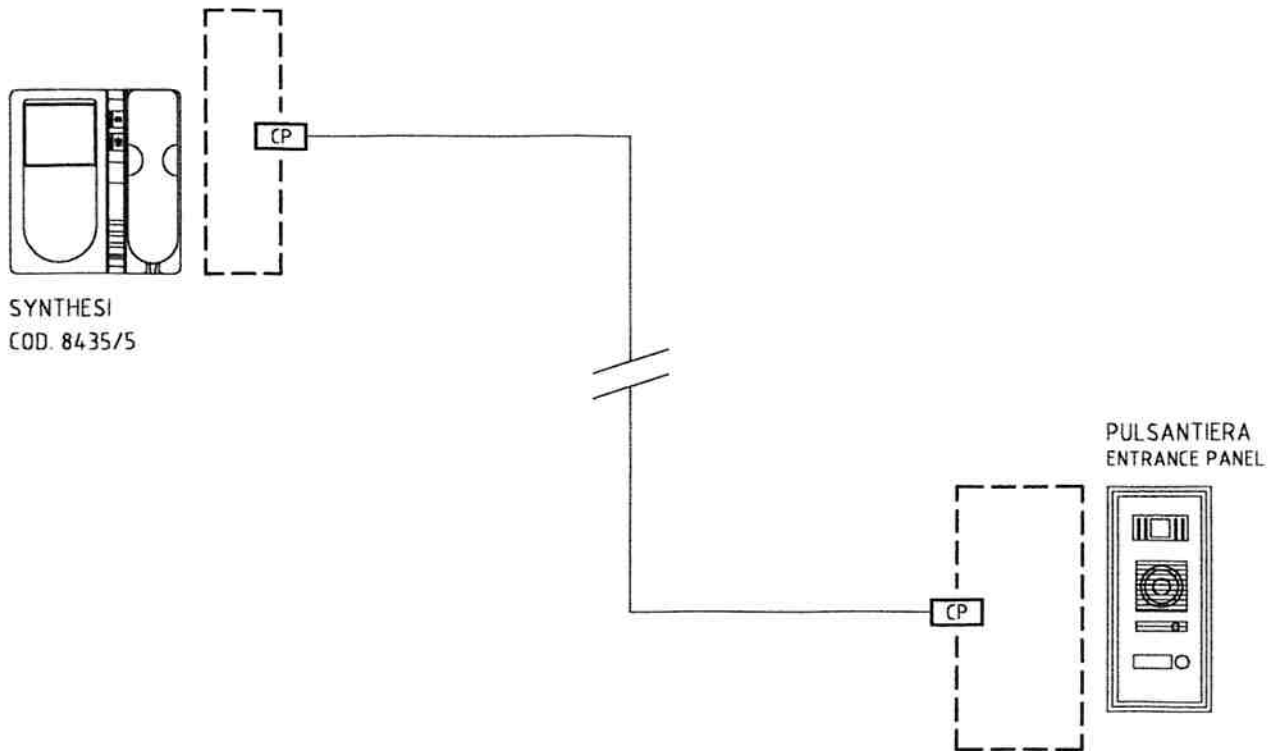

Collegamento con richiamo video dal monitor
Monitor with video recall

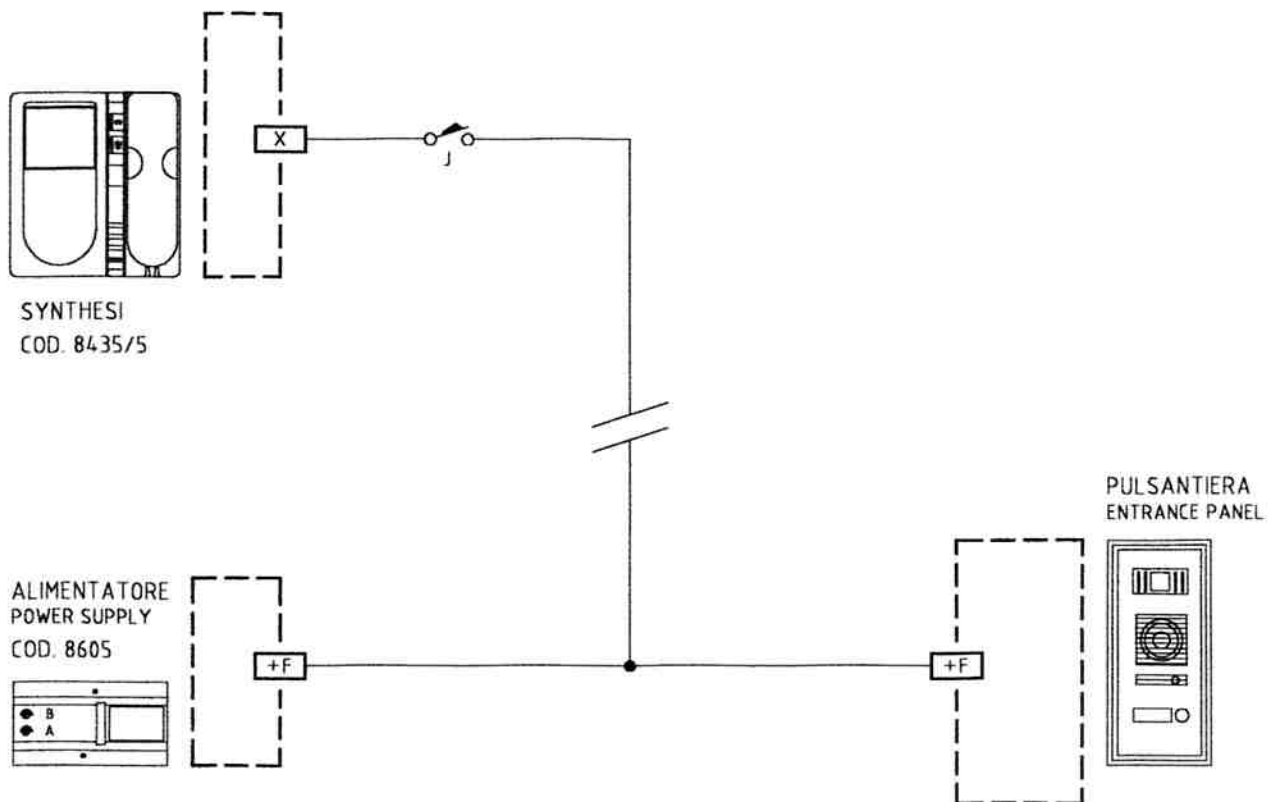

Collegamento con chiamata di piano
Apartment entrance door call

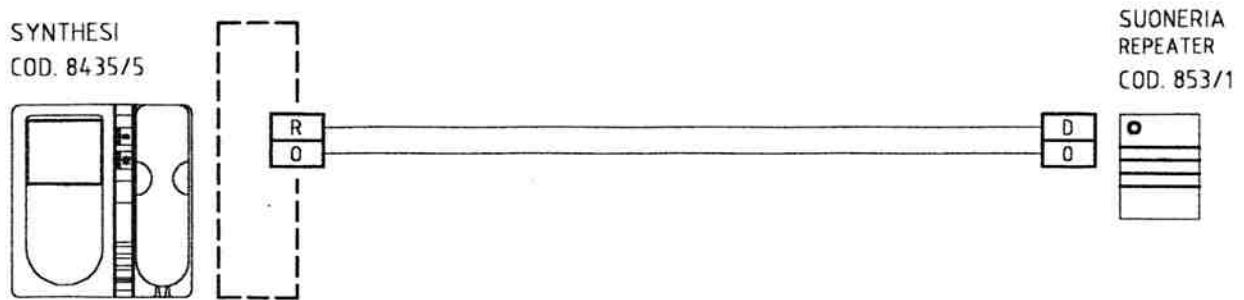

Collegamento del ripetitore di chiamata
Passive repeater for additional call

Cod. 853/1

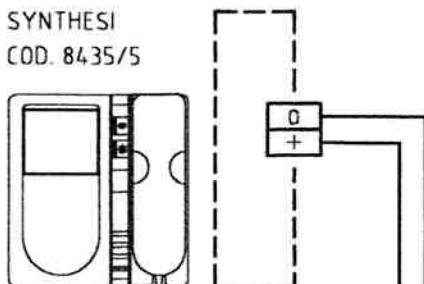

IMPORTANTE :

EFFETTUARE LA SEGUENTE MODIFICA QUANDO :

- a) LA DISTANZA FRA LA PULSANTIERA E L'ALIMENTATORE SUPERA I 100 METRI.
- b) LA TENSIONE MISURATA TRA I MORSETTI "+" e "0" DELL'ULTIMO MONITORE RISULTI INFERIORE AI 15Vcc.

IMPORTANT :

USE THIS CONNECTION WHEN :

- a) THE DISTANCE BETWEEN ENTRANCE PANEL AND POWER SUPPLY IS MORE THAN 100 mt.
- b) THE VOLTAGE BETWEEN THE CONTACTS "+" and "0" OF THE LAST MONITOR CONNECTED IS LOWER THAN 15Vdc.

ALIMENTATORE SUPPLEMENTARE
ADDITIONAL POWER SUPPLY
COD. 8605

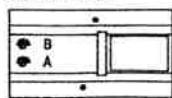

COD. 8605

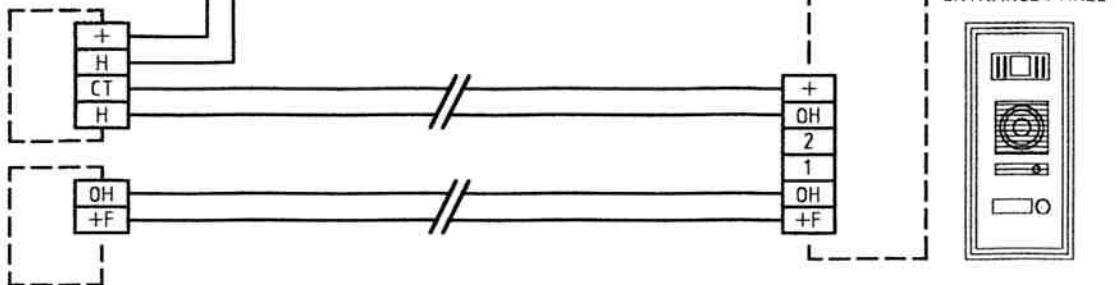
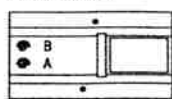

Collegamento in caso di lunghe distanze
Long distance connection

SCHEMI WIRING DIAGRAMS

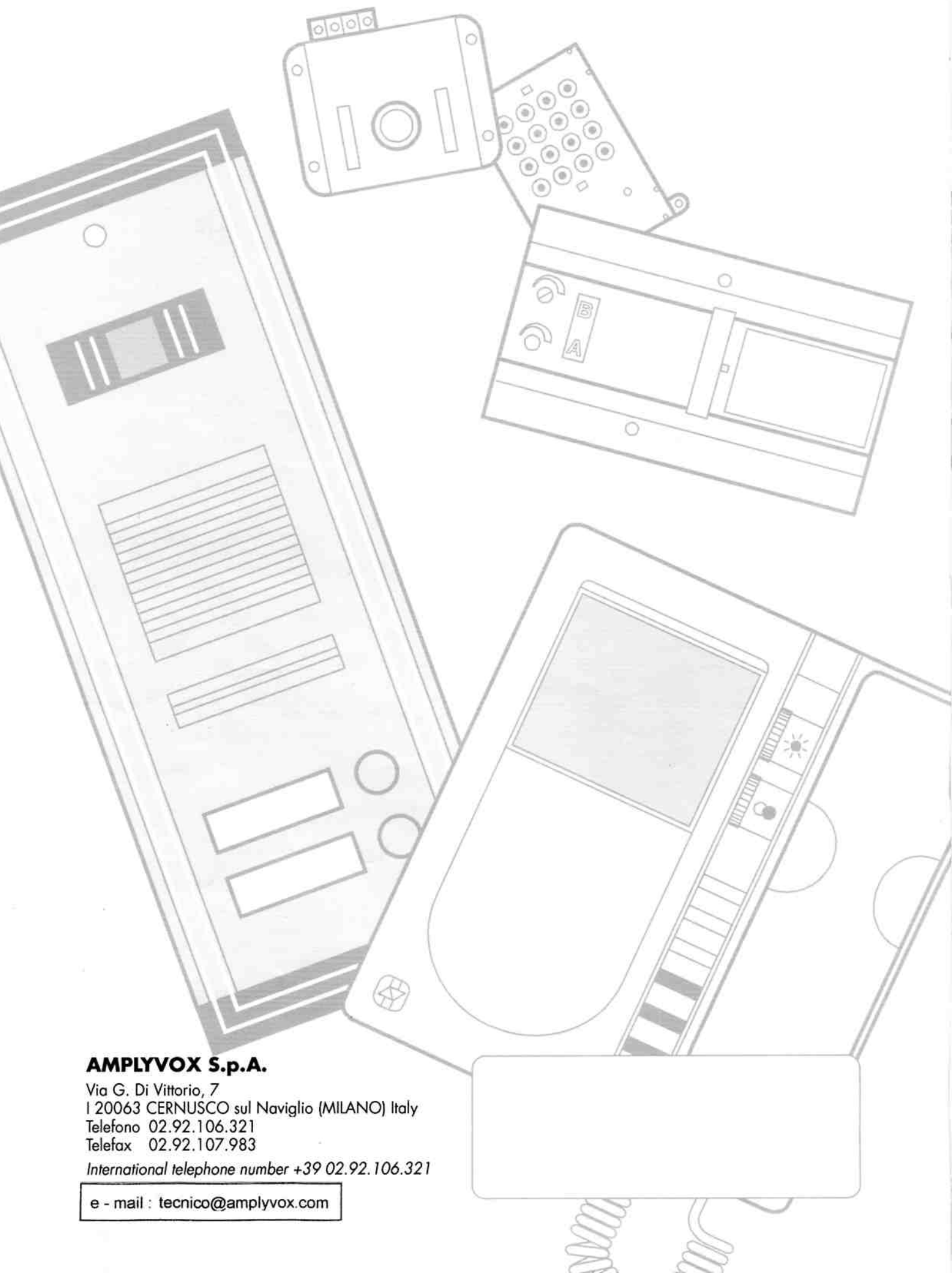

AMPLYVOX S.p.A.

Via G. Di Vittorio, 7
I 20063 CERNUSCO sul Naviglio (MILANO) Italy
Telefono 02.92.106.321
Telefax 02.92.107.983

International telephone number +39 02.92.106.321

e - mail : tecnico@amplyvox.com